



Smart Bird Nest House

Product manual

CONTENT

Warm tips.....	1
What's in the box.....	2
Bird nest specification.....	3
Bird nest structure.....	4
Introduction for camera.....	5
Indicator light.....	6
How to connect to the APP.....	7-11
APP interface introduction.....	12
Camera installation	13
How to install.....	14-15
FAQ	16-18

WARM TIPS

- 1.Keep the bird nest and all accessories out of reach of children and pets.
- 2.Make sure the camera has been fully charged for the first time.
- 3.Please do not expose the camera lens to sunlight directly .
- 4.Please do not soak the bird nest in water.
- 5.Please use 2.4 GHz WI-FI to connect the application.
- 6.Please stay away from the strong light when pairing.
- 7.Please keep the bird nest within the range of WI-FI signal.

WHAT'S IN THE BOX

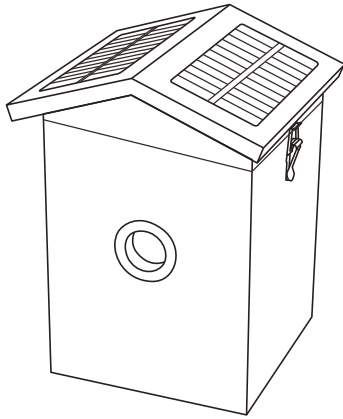

Bird Nest



Wooden mounting plate



Drill Sticker

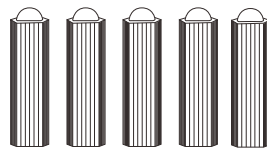

Green screws
spacers *5

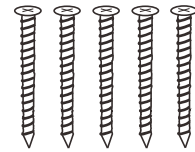

Screw for
bracket *5



Pin



Waterproof
rubber

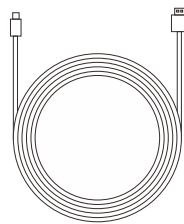

Charging cable

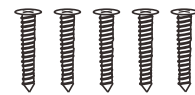

Screw for wooden
mounting plate*5

BIRD NEST SPECIFICATION

Product Model	NH01
Charging	Solar panel and USB cable
Battery	5200 mAh Rechargeable Lithium-Ion Battery
Resolution	2.0MegaPixels Photos and 1080P HD Live Stream Video
Operating Temperature	-5°F to 120°F (-20.5°C to 48.5°C)
Wireless Type	WiFi 2.4GHz
Field of View	Diagonal: 130°, Horizontal: 94°, Vertical: 40°
Dimension	L7.9 *W7.7*H12.7inches (20*19.5*32.5cm)
Power Supply	DC 5V2A
Power Consumption	2W/h(Max.)
Battery Life	4-6 years
Night Vision	Yes
Anti-flicker	50HZ /60HZ

SOLAR PANEL SPECIFICATION

IPCE	19%
Working Voltage (Vmp)	5V±5%
Working Current (Imp)	400mA±5%
Open Circuit Voltage (VOC)	7.2V±5%
Short-Circuit Current (ISC)	480mA±5%

BIRD NEST STRUCTURE

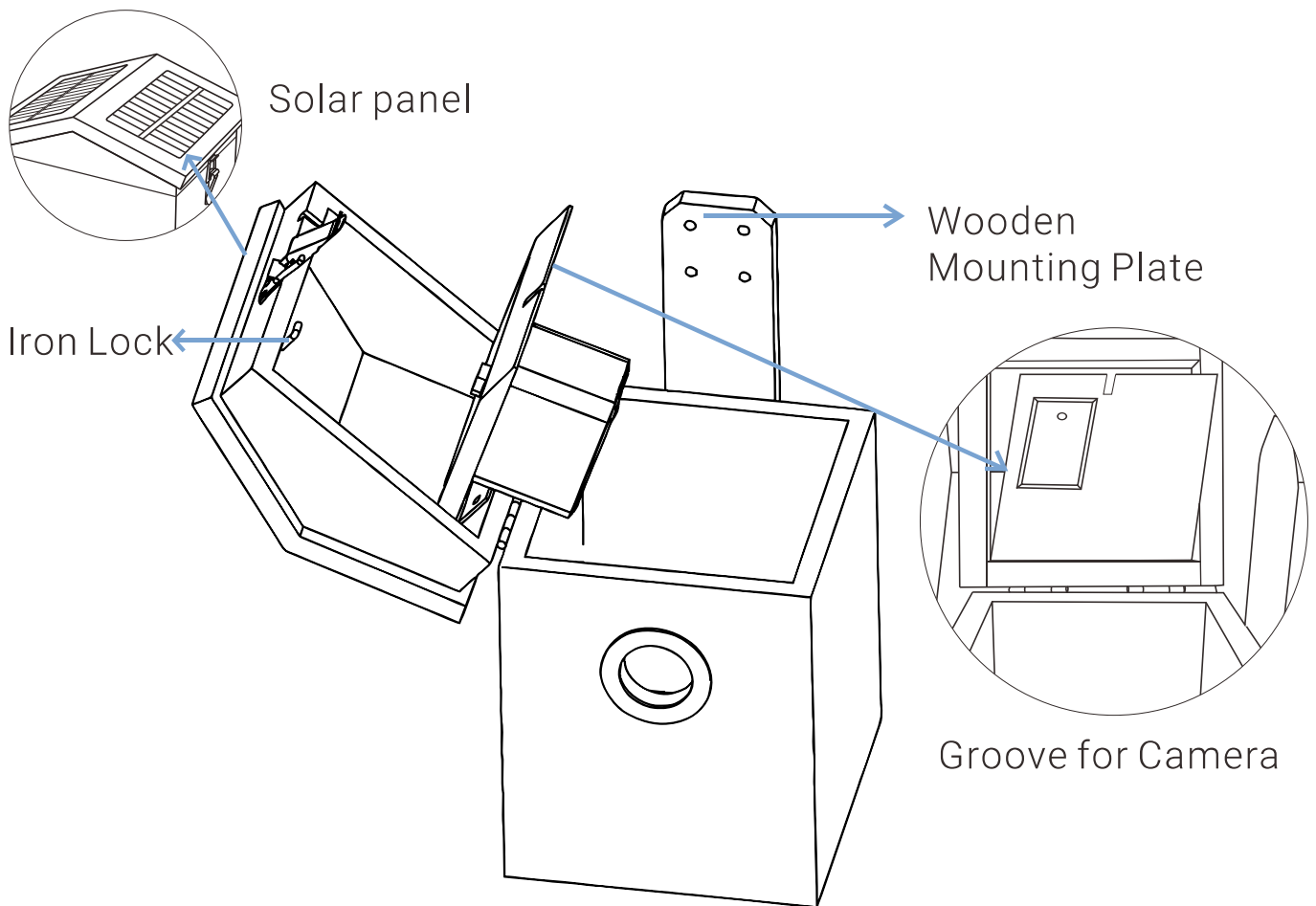

Attention: please be careful with this charging cable, in avoid of breaking off.

INTRODUCTION FOR CAMERA

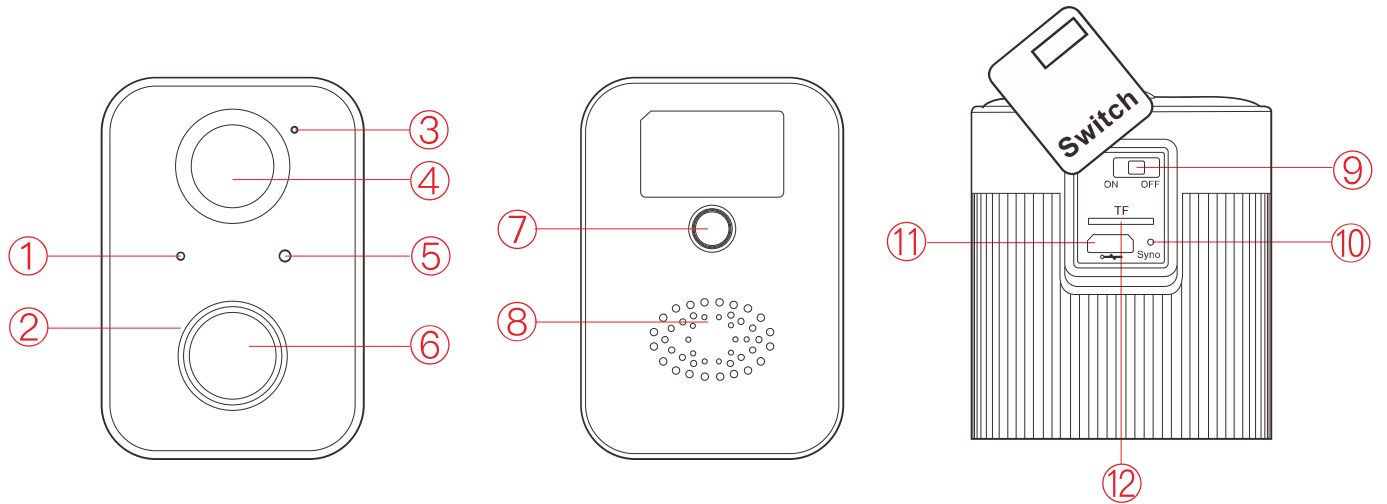

① Indicator Light

⑤ Light sensor

⑨ Power ON/OFF

② Infrared LED

⑥ Lens

⑩ Sync/Reset

③ Microphone

⑦ Mounting hole

⑪ Charging port

④ Motion sensor

⑧ Speaker

⑫ TF card slot (Capacity expansion 128G)

INDICATOR LIGHT

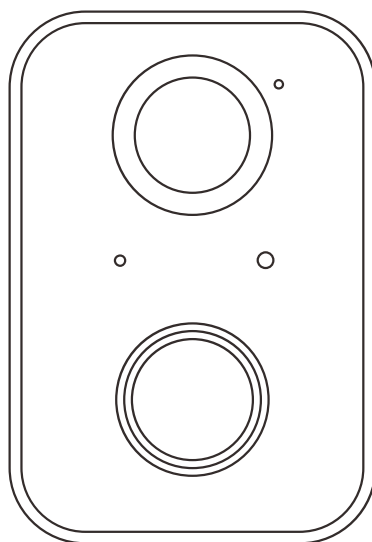

- 1.Camera turn on: Red light always ON.
- 2.Pairing mode: Red light fast blinking.
- 3.Network connecting: Green light fast blinking.
- 4.Network connected: Green light always ON.
- 5.Abnormal status : Red light slow blinking.(Need to reset)
- 6.During firmware update: Yellow light always ON.
- 7.Charging status: White light always ON during charging and OFF after fully charged.

HOW TO CONNECT TO THE APP



Download or scan the QR code and install the Bird Lover App for either IOS or Android. Once downloaded, the APP will prompt you to register your device. Enter your phone number or email address which one makes you feel comfortable and select the country you live in. You will receive the registration code. Input the registration code, then create a password.

1. Turn on the power switch.

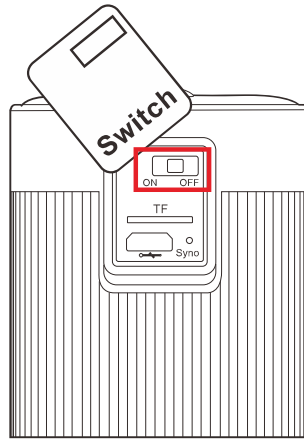

2. Open the APP and connect according to the following steps.

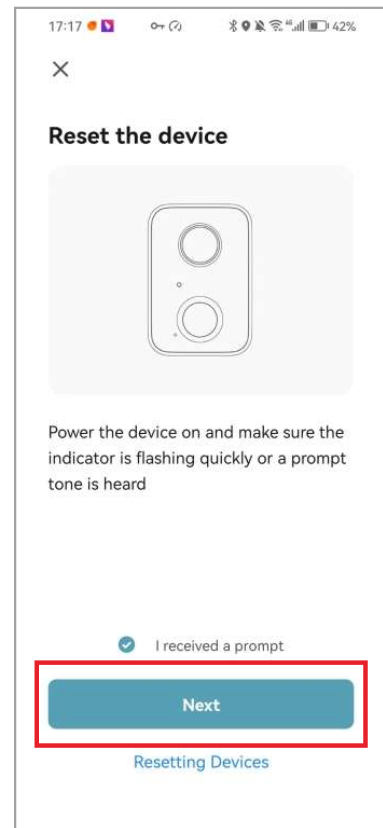
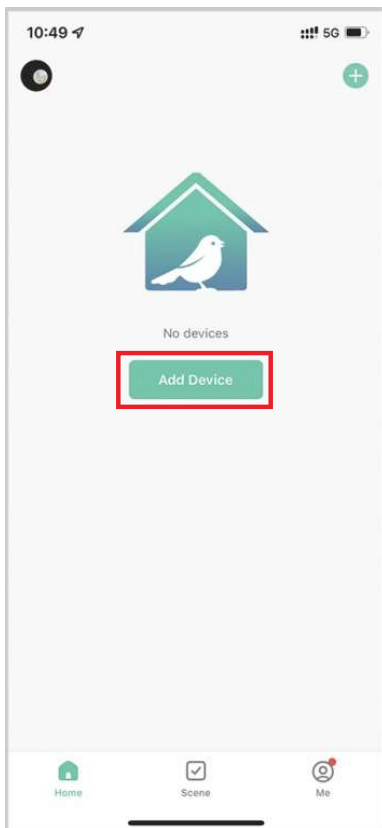

3. Use the pin to press the reset (Sync) button and holding for 5 seconds till the indicator light blink red color repeatedly.



4. Enter the WIFI password.

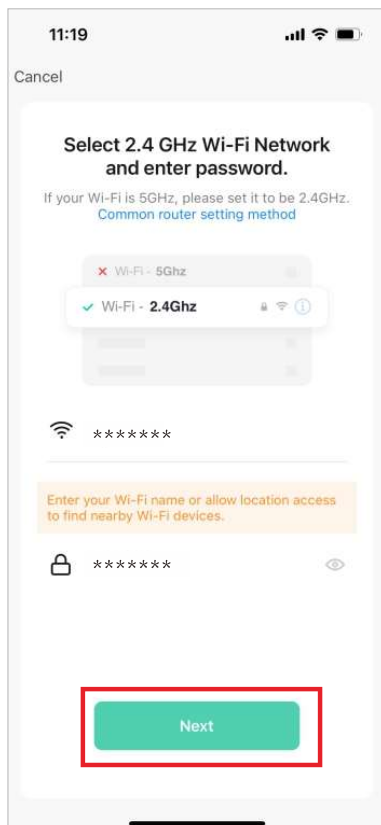

4. Scan the QR code with the camera, and enter the connection after hearing the sound of the camera prompt.

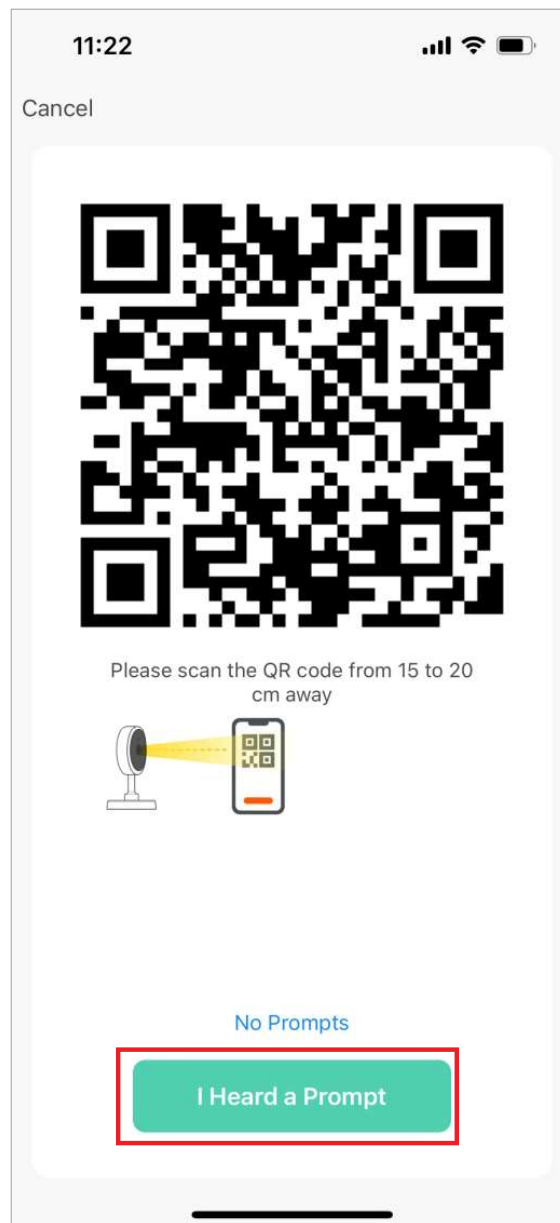

5. Wait for the connection to complete, and click "Done" .

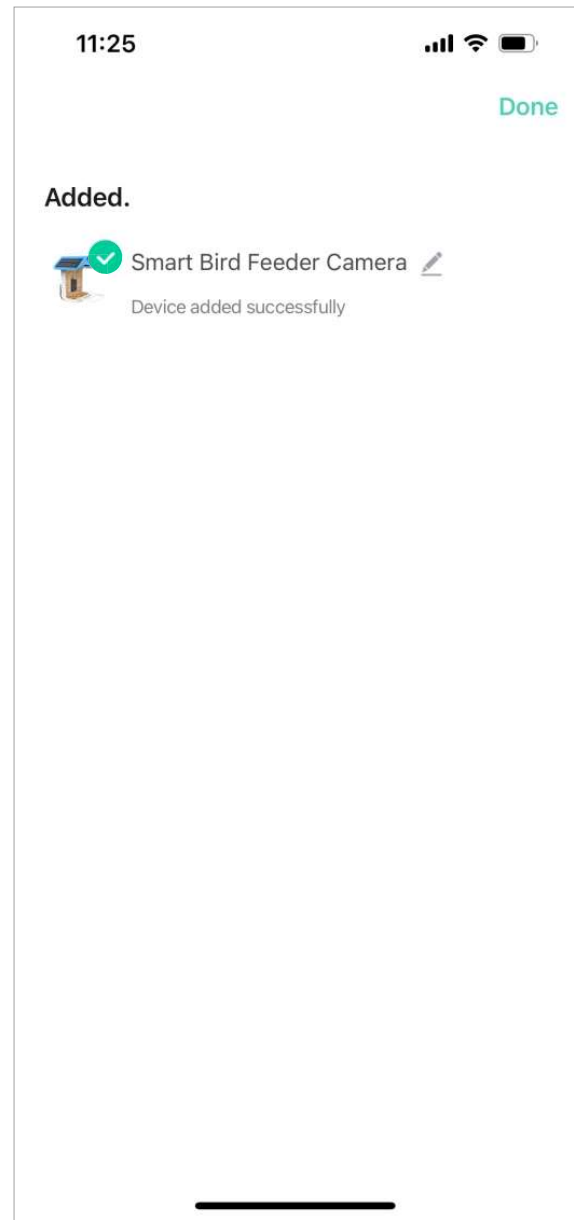
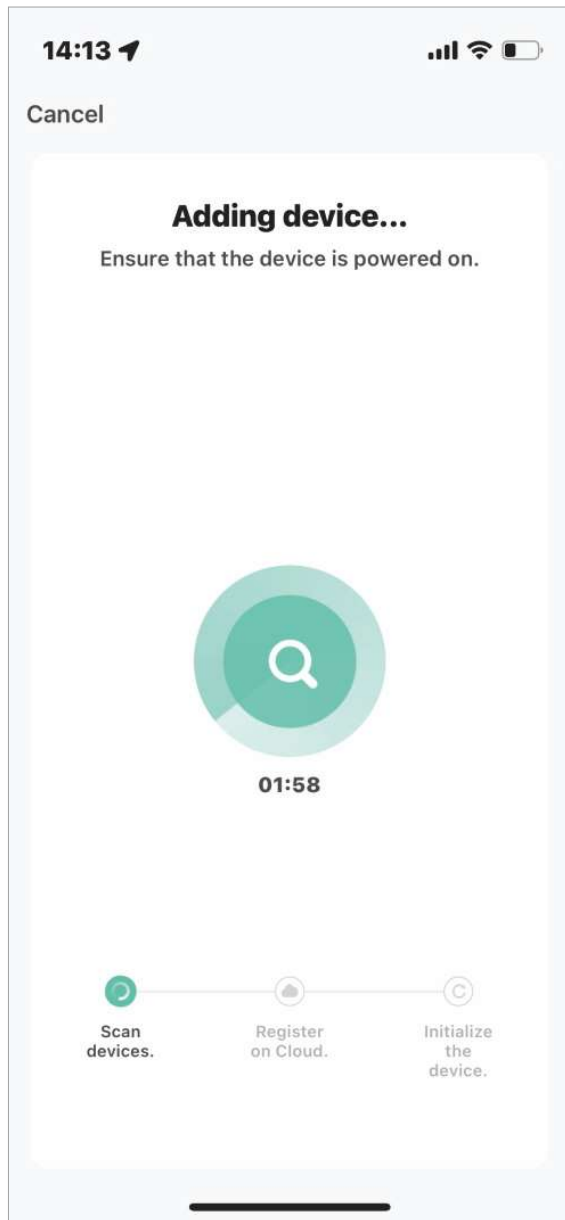

APP INTERFACE INTRODUCTION

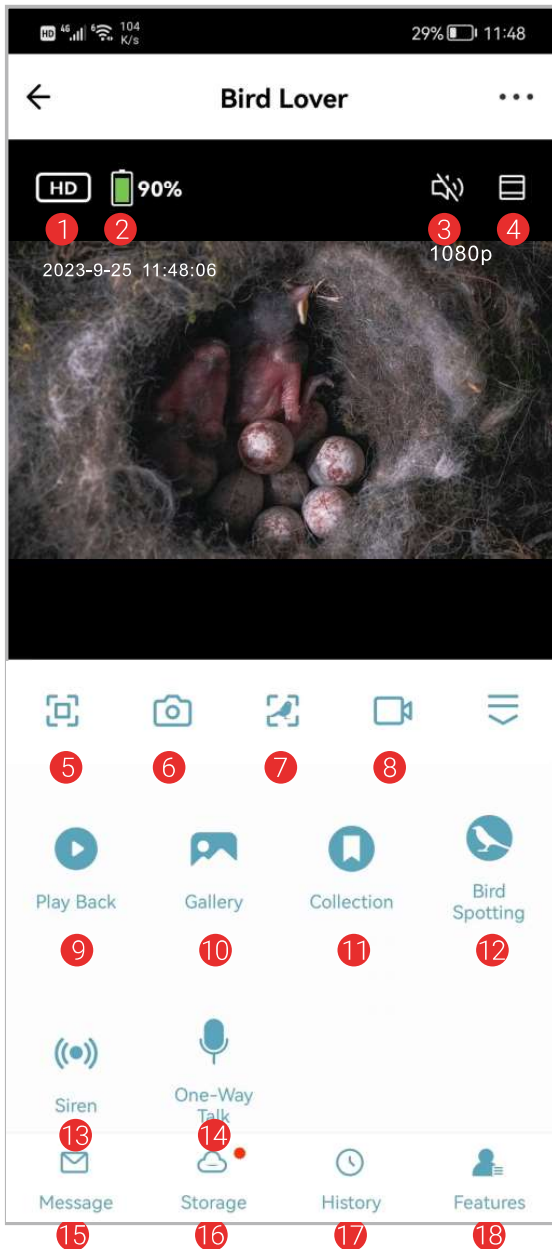

1. Quality adjustment: you can choose HD or SD
2. Battery Remaining Capacity
3. Voice switch
4. Zoom in the screen for camera
5. Screen horizontal and vertical adjustment
6. Take photo
7. Bird recognition
8. Shot videos
9. Playback for previous
10. View photos or videos took
11. Check out the bird collection
12. Motion detection (Click to turn on/off)
13. Siren
14. One-Way Talk
15. Notification for motion detection
16. Cloud storage service
17. History for bird recognition
18. Back to all function interface

CAMERA INSTALLATION

1. The inside wood board was installed with groove for camera which can fix the camera tightly and make it steady.

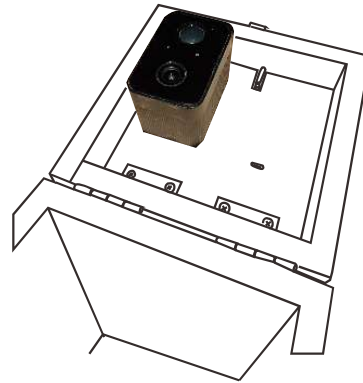
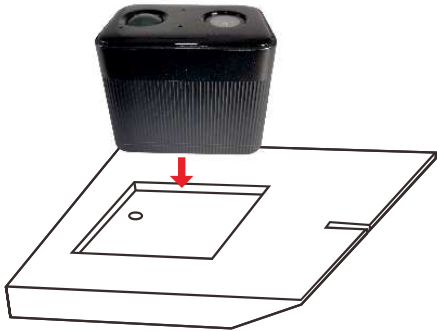

2. Make the camera's screw hole match to the screw, then tighten it. Turn the iron lock, fix the wooden board, then lock it below the wooden roof.

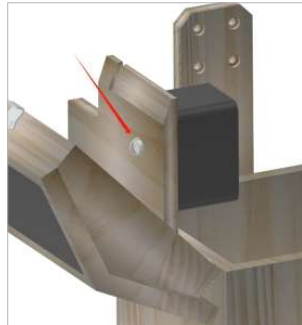
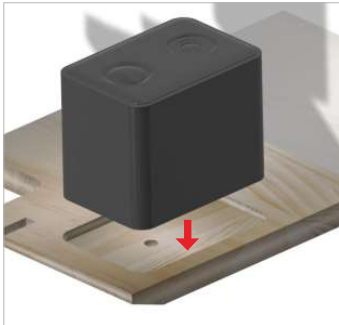

3. Below picture show you the internal structure.



HOW TO INSTALL

1. Use the screwdriver to twist the screw into the board.



2. Stick the sticker on the wood or wall and drill holes within the range marked on the sticker.



3. Insert the green plastic screw spacers into the hole.



4. Fix the board with long screws



5. The bird nest can be fixed tightly.



FAQ

Q: Do I need to create an account to use the App?

A: Yes, you need to use email address or phone number to get a verification code for registering an account .

Q: What operating systems are the App compatible with?

A: The App is compatible with Apple iOS and Android system.

- IOS 10.0 and above.
- Android V5.0 and above.

Q:What Wifi band does the AI Camera support?

A: 2.4Ghz WiFi only.

Q: How many accounts can be linked with one Smart Bird Nest?

A: The Smart Bird Nest can only be linked to one account at a time. If it is linked by other accounts, please Long press the reset button for 10s to release.

Q: Can I share the Smart Bird Nest with other users?

A: Yes. You are able to share the Smart Bird Nest with other users however they will need to install the "Bird Lover" app.

When the App is ready, any of the following methods is optional to share the device:

- If they have individual account:
 - 1.Sharing the device by adding the their account names.
 - 2.Adding new accounts to your family group.
- If they have no individual account:

Using your main account and password to log in the same way as you do.

Q: What's the language of the App?

A: The App's language will match your device's system language. But the Language of AI recognition result only supports English or Chinese now.

Q: Why is the camera battery draining so fast?

It is low power consumption camera. Plus the solar panel power in charge, it can maintains the daily energy consume in sunny day. If the battery drains too fast you should check:

1. Whether you check the camera with APP too often?
2. Whether the camera always wakes up due to too many birds visiting?
3. Do the Wi-Fi performance is good or not? Once the camera lost Wi-Fi or Wi-Fi is too weak, the camera will scouring the Wi-Fi signal again and again, till the power used up?

Q: Why the "Playback" is not available?

A: Check the following:

1. Please confirm that the TF card is installed correctly or the payment action of cloud storage has been completed. If the TF card cannot be read, please format it to FAT32 with computer. Our product support 4G-128G TF card.
2. Please make sure you have enabled recording in the "Recording Settings" And turn on the detection mode.

Q: How to turn on or turn off the message notify?

- A: 1. Enter the main page and find “Me” on the left bottom, click icon “📍”
And set the app notification to turn on or off “Enable Notifications”. You can also set up a schedule for “Do-Not Disturb Schedule” at the same interface.
2. Turn on or off the “Motion Detection” at the UI interface.
 3. Turn on or off the “Detection Alarm Settings” on the Setting interface.

Q: What should I do if the device is not working properly?

1. Please check whether the power cable is correct plugged in and make sure the power switch is turned on.
2. Please check whether the WI-FI is available and the smart bird nest is work at the range of WI-FI.
3. Please remove the device and reconnect it.

Only three steps, before you enjoy the fun which Smart Bird Nest House bring to you.

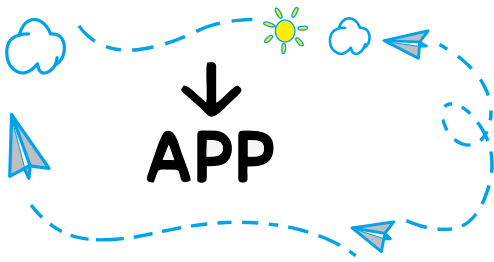

1. Down load the App in your Smart Phone and create a account. (P7)

2. Add the camera on the App.(P8-P11)

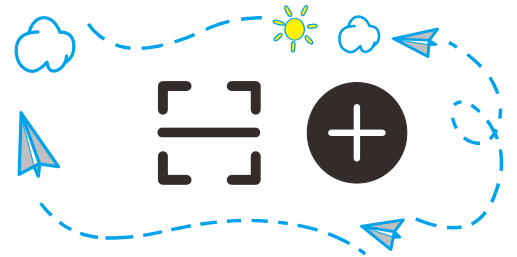

3. Installing the Bird Feeder in the reasonable place. (P13-P15)

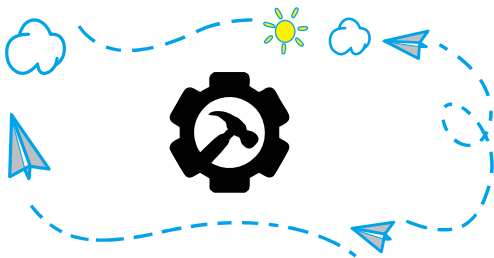

4. Live-stream the camera on the App and operate it. (P12)

